

SECTIONAL DOORS

RESIDENCIAL



WWW.FLEXIDOOR.PT

 **Flexidoor**
AUTOMATIC DOORS MANUFACTURER



RECOGNIZED QUALITY

Flexidoor sectional doors fulfil all the European standards for safety requirements. All the safety components are an integral part of our door, giving our customers the guarantee that our products are designed to ensure safety and well-being.



TECHNICAL ASSISTANCE

Flexidoor has a specialized and skilled technical team which offers you all the necessary support since the planning up to the installation phase. This way, safety will be at your side during the time of work execution.



WELL-BEING IS ALWAYS ON OUR MIND!

Nowadays aesthetic appearance of our homes has a huge importance, even because it is fundamental that we feel good in what is, after all, our home. So we have at your disposal different types of sectional doors with the most varied settings so that you can always get what you want.



SECTIONAL DOORS PANELS



PANELS

Flexidoor sandwich panel has a set of features that allows the panel to obtain optimum characteristics of thermal insulation, acoustic insulation, water tightness and resistance to wind load. For this, Flexidoor uses a modern technology on its factoring process, allowing total control over the product quality as well as the ability to handle with all orders.

In order to achieve the most demanding needs, Flexidoor also offers 80 mm Panel. Guided to Industrial doors, where a higher level of thermal insulation or greater wind resistance is required, the 80 mm thick panel is the perfect solution.

PANEL

THICKNESS

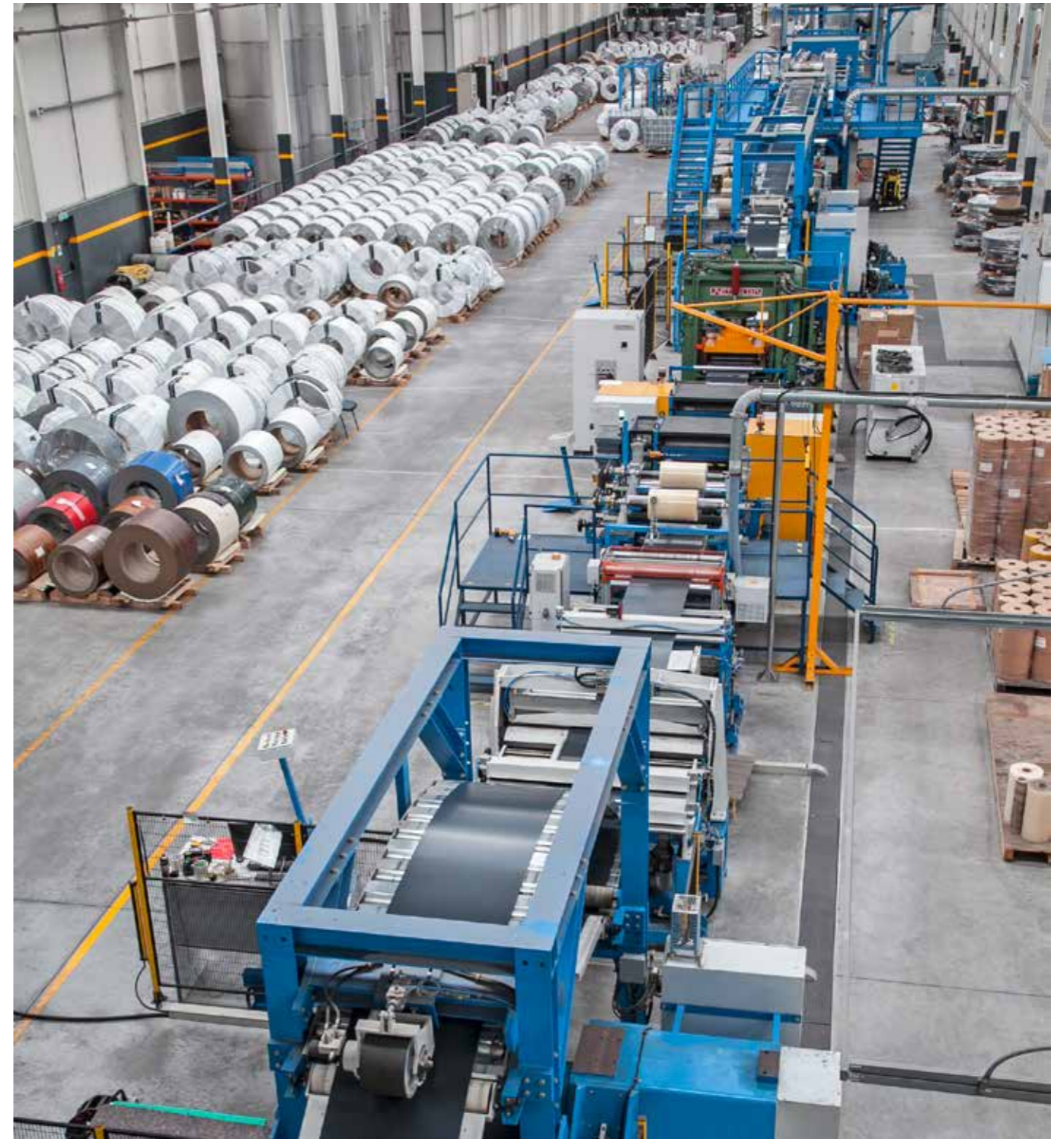

Technical Specifications

- Heat transfer coefficient:
 - Panel 610 mm with seal: $U= 0.76 \text{ W/m}^2\text{K}$
 - Panel 500 mm with seal: $U= 0.80 \text{ W/m}^2\text{K}$
 - Panel 610 / 500 mm without seal: $U= 0.53 \text{ W/m}^2\text{K}$
- Closed cell content: $\pm 94\%$
- All panels are lined internally and externally with a protective PVC film
- Density: $\pm 45 \text{ kg/m}^3$
- Adhesive strength: $\pm 0.10 \text{ MPa}$
- Compressive strength: $\pm 0.13 \text{ MPa}$
- Compressive Modulus of Elasticity: $\pm 2.68 \text{ MPa}$
- Thermal conductivity: $\pm 0.14 \text{ W/mk}$



GROOVE PANEL

FINISHING



GROOVE



GROOVE WITH 1 LARGE RIB



GROOVE WOOD



9010 9006 9007 7011



9010

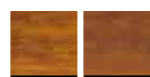

LIGHT DARK



7016 1015 3000 8014



8017 6005 6009 5010



OTHER AVAILABLE RAL COLOURS

NOTE: Finishing and colours are only available on the 40mm panel.





FRAME PANEL

FINISHING



FRAME



FRAME WOOD

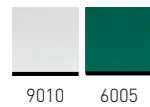

9010 6005



LIGHT DARK



OTHER AVAILABLE RAL COLOURS

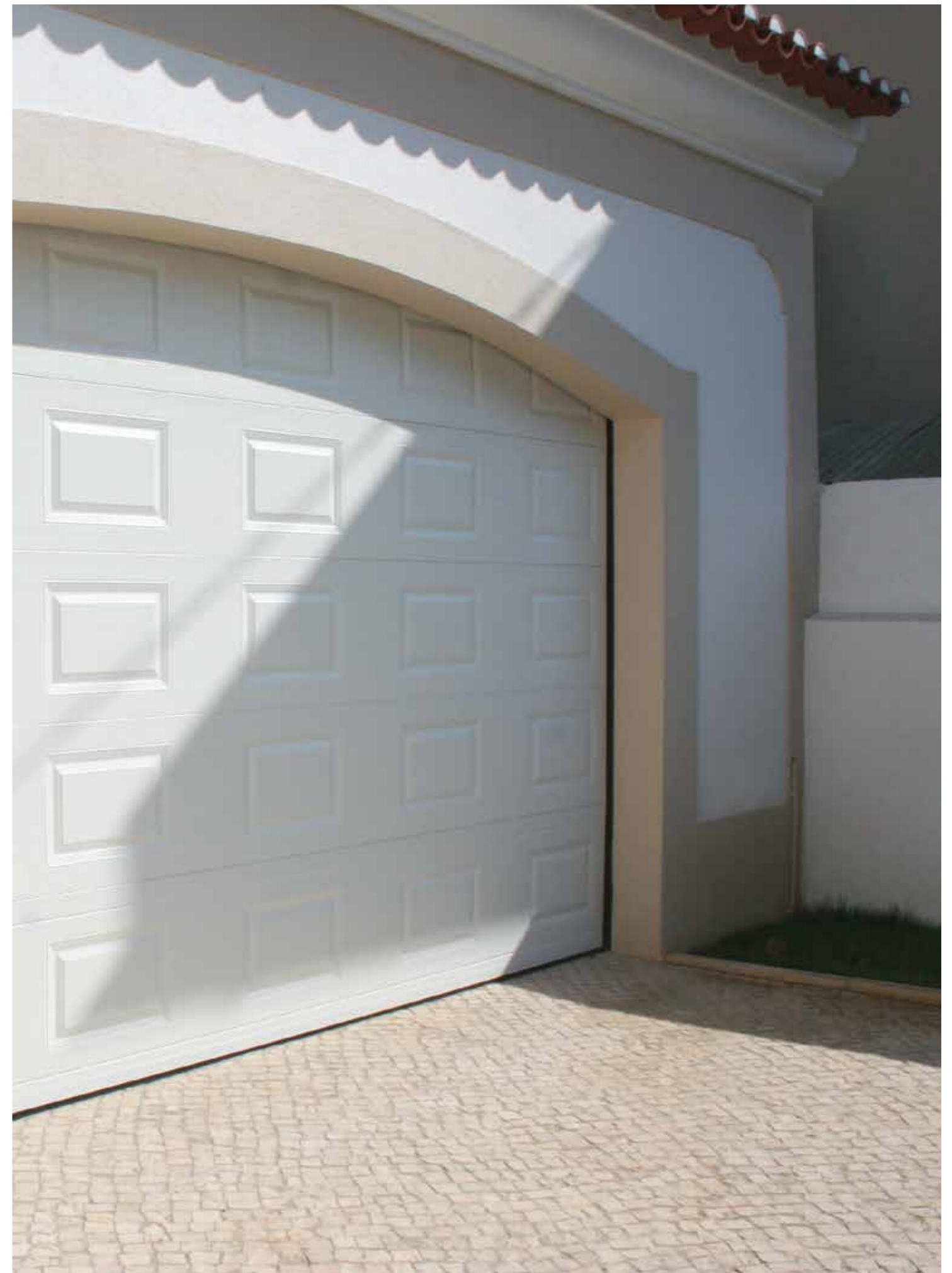

NOTE: Finishing and colours are only available on the 40mm panel.



FLAT PANEL

FINISHING

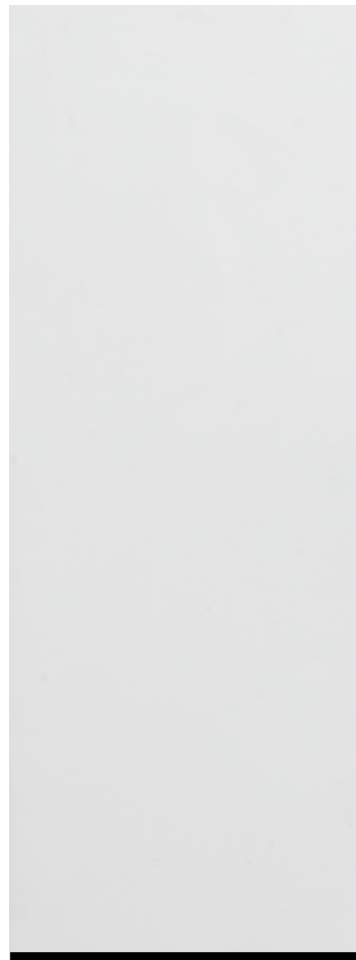

WHITE FLAT

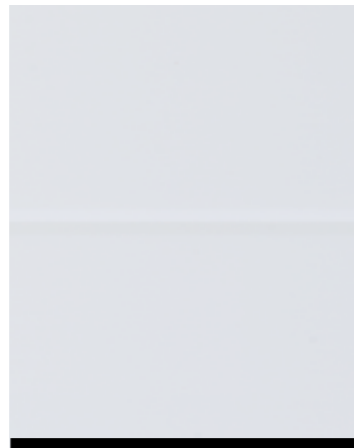

WHITE FLAT WITH 1 RIB



WOOD FLAT WITH 1 RIB



WOOD FLAT



9010 7016



9010



LIGHT DARK



LIGHT DARK



OTHER AVAILABLE RAL COLOURS

NOTE: Finishing and colours are only available on the 40mm panel.

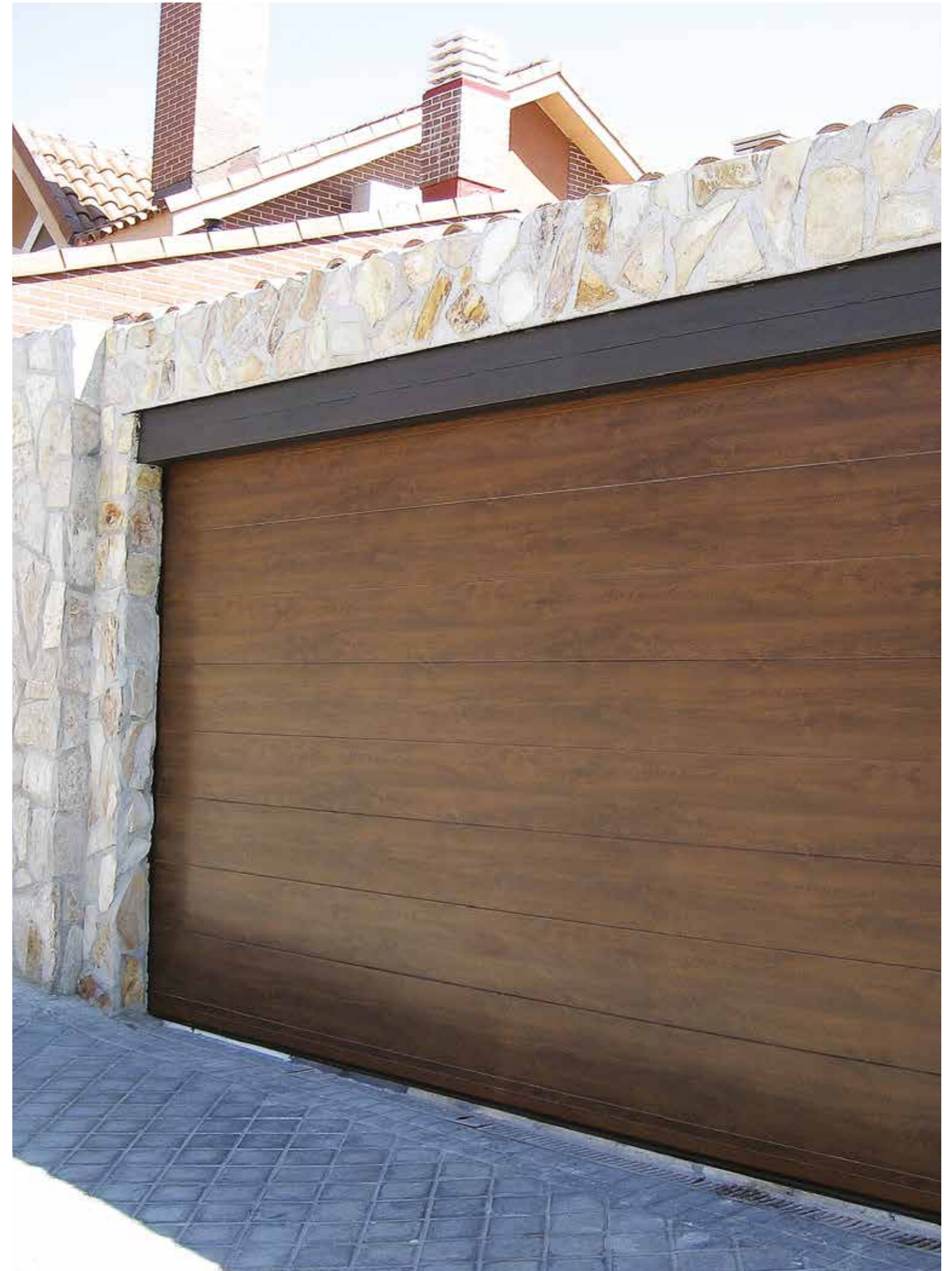



MICRO RIB

PANEL

FINISHING



MICRO RIB



9010



OTHER AVAILABLE RAL COLOURS

NOTE: Finishing and colours are only available on the 40mm panel.

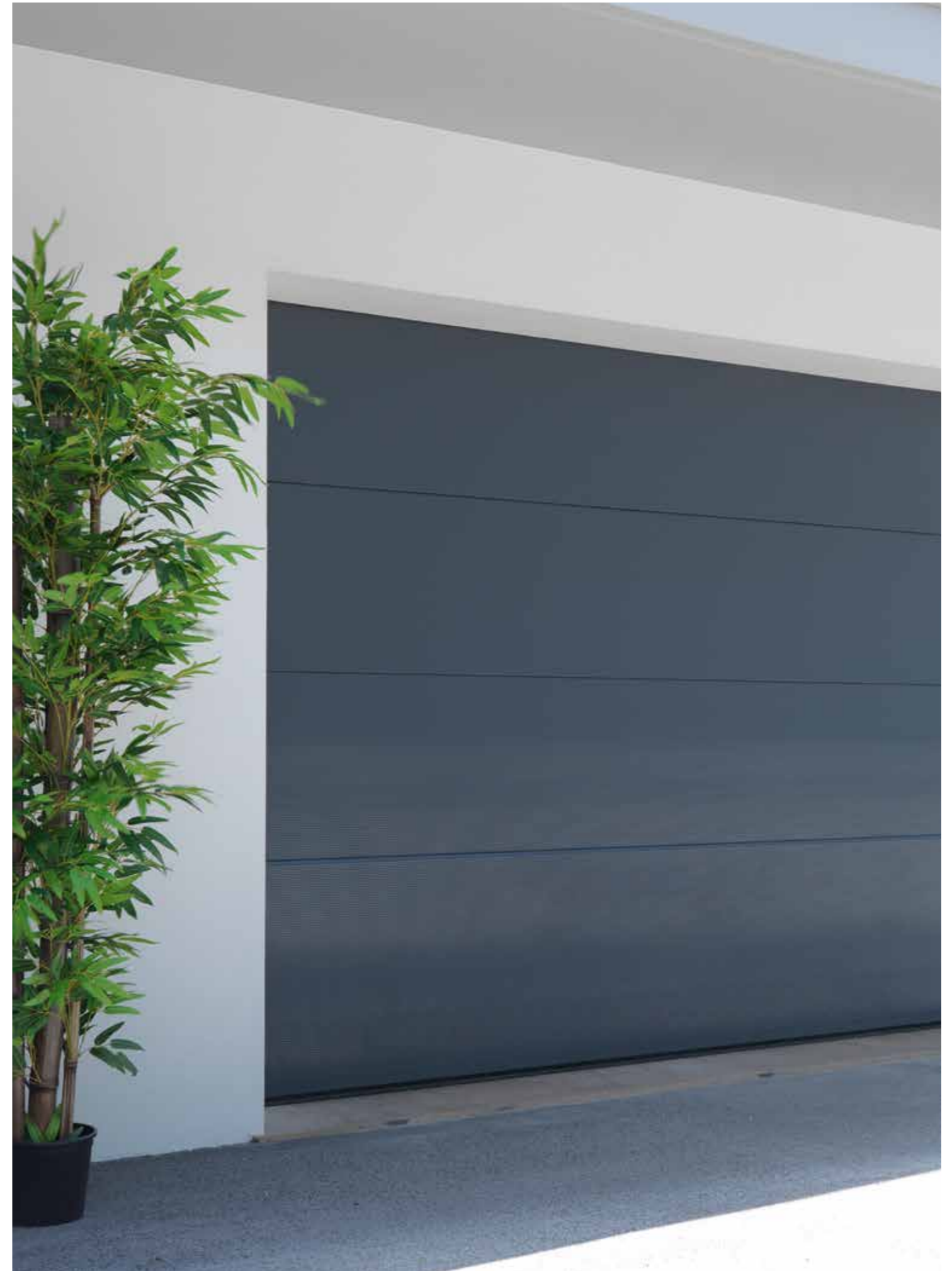

DARK DESIGN

PANEL

FINISHING



DARK DESIGN

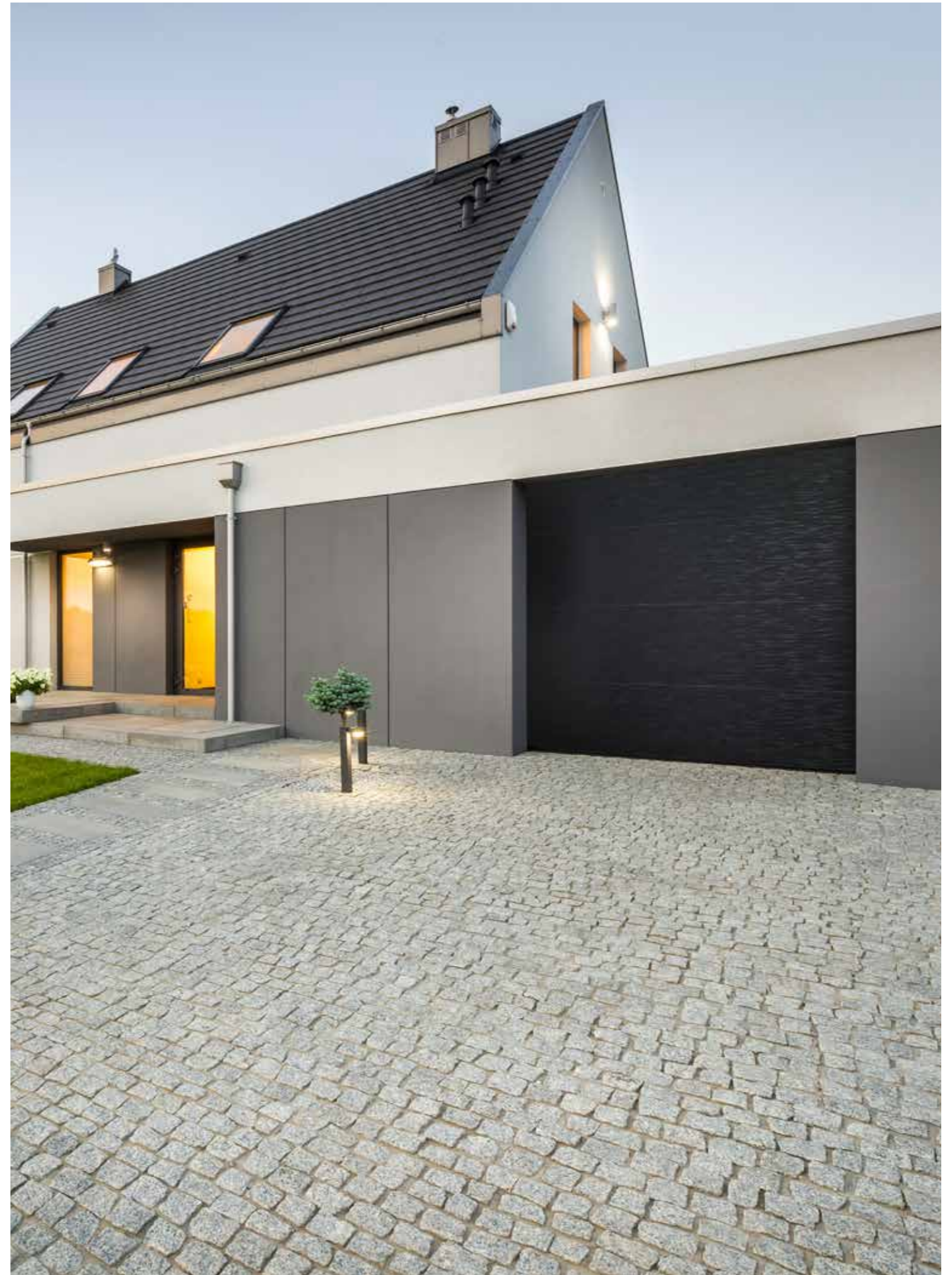

NOTE: Finishing and colours are only available on the 40mm panel.

CROSS

PANEL

FINISHING



DARK CROSS



SILVER CROSS

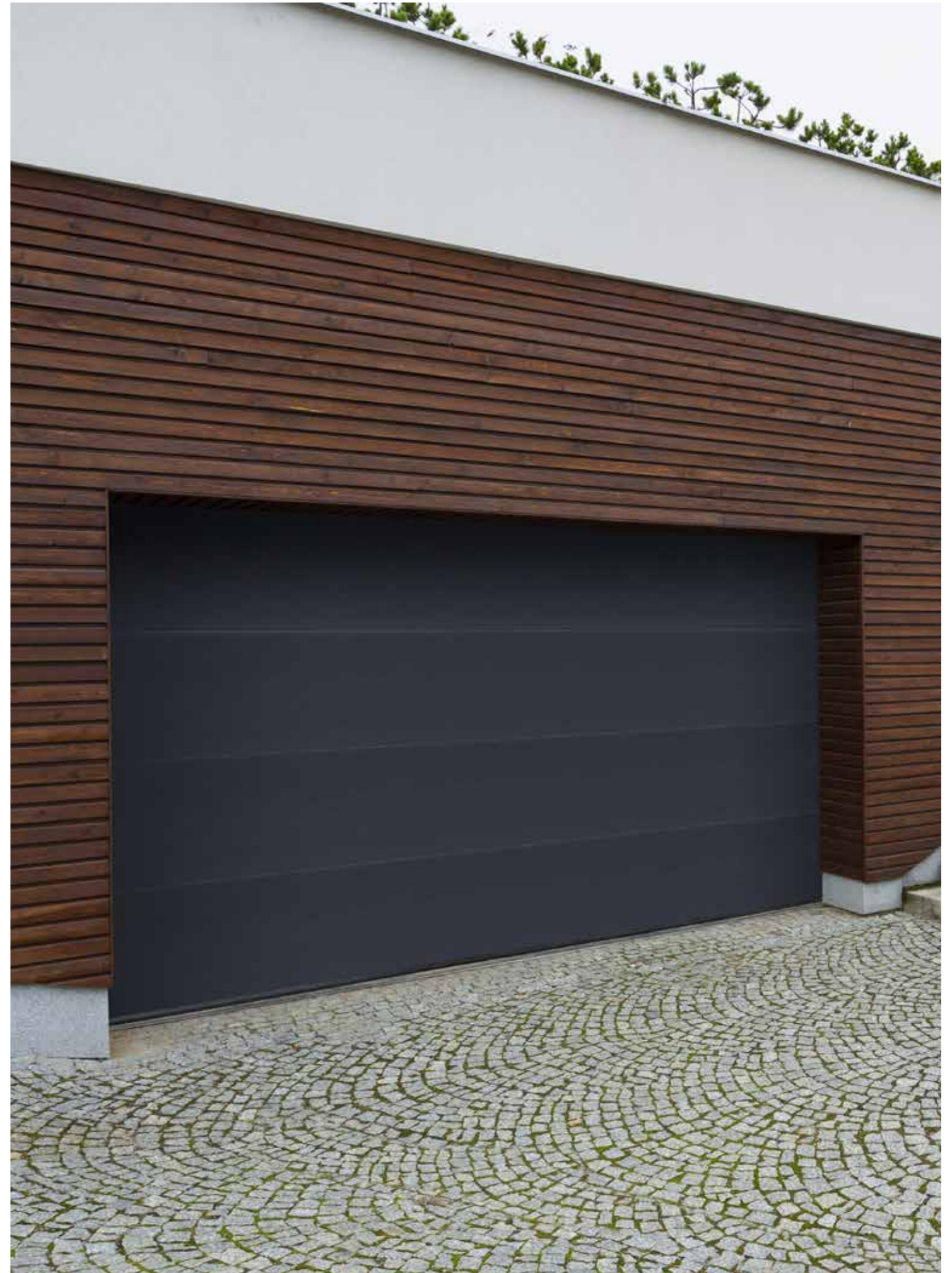

NOTE: Finishing and colours are only available on the 40mm panel.

INOX DESIGN

PANEL

FINISHING



INOX DESIGN

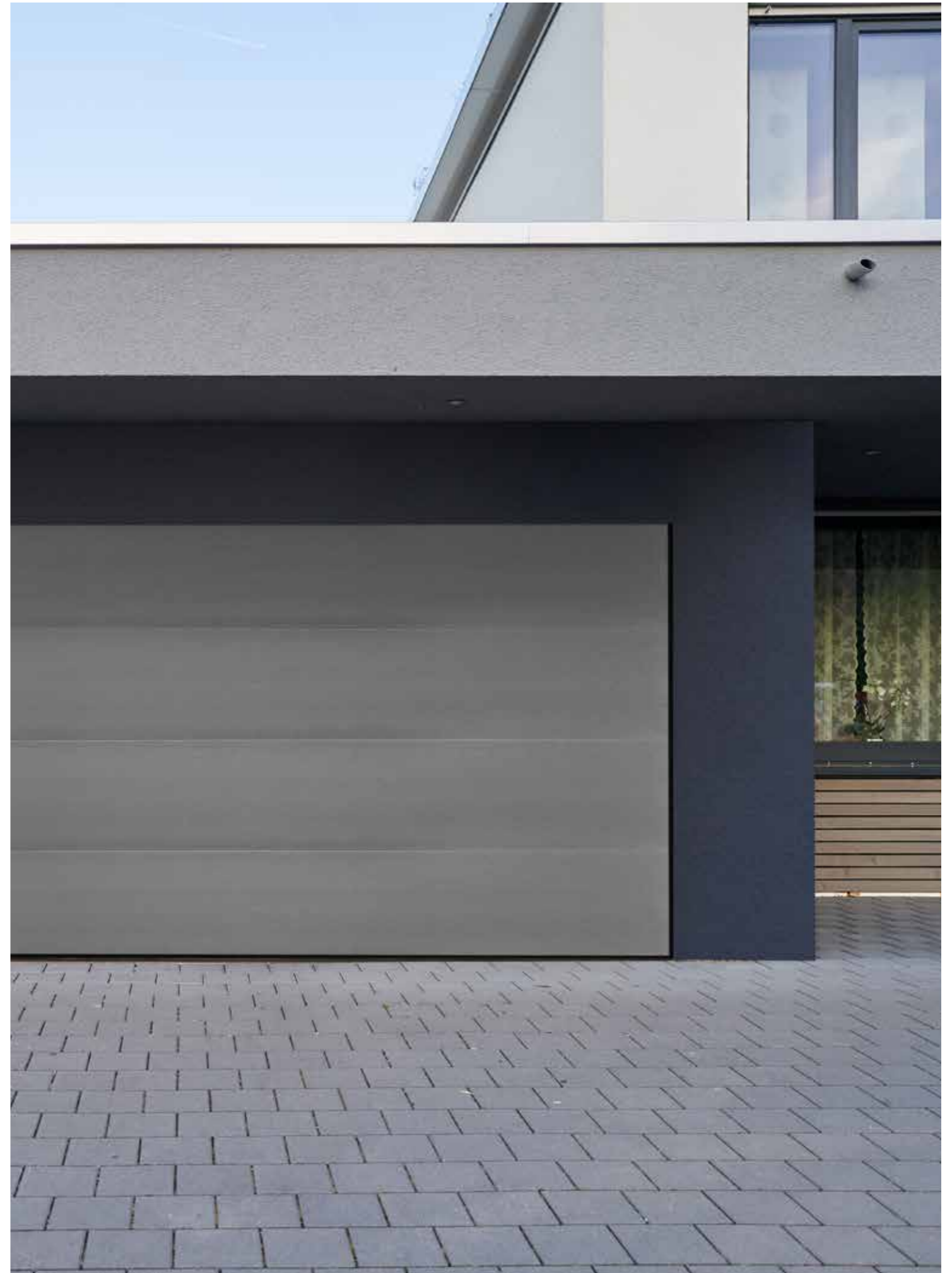

NOTE: Finishing and colours are only available on the 40mm panel.

COPPER

PANEL

FINISHING



COPPER



NOTE: Finishing and colours are only available on the 40mm panel.



RESIDENTIAL SECTIONAL DOORS



FLEXIDOOR

Flexidoor considers the innovation a form of learning about the new ways of offering a better product to our customers. As well as the continuous efficiency gains demand with the objective of creating value for the entire organization and its partners. Thus, the day by day R&D Department

work is filled with new challenges that we believe define who we are.

This is our identity.

This is our future.

COMPOSITION OF PLUS DOOR



01
The headroom rubber seal improves the tightness of the door and the aesthetics on the outside.



04
The new connection brackets for supporting the horizontal tracks from the ceiling, eases assembly and the adjustment of the tracks, and gives the door a cleaner look. Available for headroom up to 600mm.



02
The interior latch is supplied to give more safety.



05
The rear connection profile and angle bracket ensures the correct spacing between horizontal tracks, and increases robustness of the entire door.



03
The new design improves the action of the rollers, making the door operation more smooth and quiet. In addition, increases the robustness of the track, improves safety against cutting and increases the durability of the door.



06
Elegant and innovative design, is flexible for allowing several setting points and robust because it has a steel solid structure. Characteristics 100% conceived, designed and manufactured by Flexidoor.

FLEXIDOOR ON THE LEAD OF CONSTRUCTION

Designed thinking on the installation process and in the improvement of the appearance, Flexidoor presents its New CLIP System. The clip wall console allows headroom "built-in" with springs in front of 130mm, and makes the installation of the spring system much easier especially with only one installer. The spring safety device is hooked to the wall console, and the spring fitting is no longer fixed to the spring safety device, but "clamped" into it. This new mounting system will be the same for the three types of headroom most used: Reduced, Low and Normal. All of this makes the system more robust and easier to mount. Available for springs up to 67mm of diameter.



LEVER HANDLE | EMBEDDED HANDLE

The Flexidoor sectional doors allow the customer to choose between three different types of handles: one Lever handle and two Embedded. The decision is based on functional factors or simply in the personal style of each customer.

COMPOSITION OF BASIC DOOR



Flexidoor Flexidoor - Portões Seccionados e Automatismos, S.A. Rua da Majoira nº400, Ponte da Pedra 2415-184 Requinte de Portos - Portugal	
Standard EN 13241:2003+A2:2016 No. 08521017	
Door type Sectional Door GROOVE Low Lintel w/ clip system	
Model GROOVECLIPRE	Type of Use Garage and Industrial
Production Date 10.10.2017	Serial Nº / O.F. 0852/10/17
Width 3000	Height 2000
Lintel 130	
Nº Turns of Spring: 9.2	
Cable Drum - Nº of Free Conical Turns: 0	
H3R0V5U1 0A4G0F1D0B24E1 5	
Resistance to Wind Load Class 5 [1110Pa]	Water Tightness Class 3 [70 Pa]
Sound Insulation (dB) 24dB	Thermal Resistance 1,0 [W/mK]
Air Permeability Class 4	Mechanical Durability 15000 cycles
Other characteristics declared as Pass: -Operating Forces* -Release of dangerous substances -Definition of geometry of glass components -Force for Manual Operation -Safe openings -Mechanical Resistance -Protection against Cutting and Tripping -Protection against crushing, shearing and drawing-in -Electrical Safety -Electromagnetic Compatibility *Evaluation of conformity based on initial type testing	
Mod.041-04 Made in Portugal	
Directives: Reg. nº 305/2011, 2006/42/EC, 2014/30/EU EMC, 2014/53/EU RDE, 2011/65/EU RoHS	
	

RECOGNIZED QUALITY

Flexidoor sectional doors fulfill all the safety requirements of the EN 13241:2003 standard.



FLEXIDOOR ON THE LEAD OF CONSTRUCTION

The spring brakes devices and torsion springs are centrally aligned and installed in a traditional way, allowing a minimum lintel of 150 mm.



01

Rubber seal on top panel.



02

The new design improves the action of the rollers, making the door operation more smooth and quiet. In addition, increases the robustness of the track, improves safety against cutting and increases the durability of the door.



03

Perforated angle bracket to fit the horizontal tracks to the ceiling.



04

Metallic side hinges.

WINDOWS



PVC FRAMES



Plain Acrylic



Plain Acrylic with Cross effect



Plain Acrylic with Rhombus effect

Aluminium Frames



Double Laminated Plain Glass



Double Laminated Plain Glass with Cross effect



Double Laminated Plain Glass with Rhombus effect

PVC and Stainless steel Frames



Round window black PVC Frame
Diameter: 330 mm



Round window Stainless steel Frame
Diameter: 240 mm or 330 mm



Square window Stainless steel Frame
Width: 310 mm • Height: 310 mm

AVAILABLE IN GLASS: Plain, frosted and granulated.

PVC Sun effect



Sun effect with 5 acrylic windows



Sun effect with 3 acrylic windows

WINDOWS

Width: 530 mm • Height: 365 mm
Dimensions common for all windows.

AVAILABLE IN GLASS AND ACRYLIC:
Plain, frosted and granulated.

NOTE:In the window with acrylic, the effects only exist in RAL colour 9010.

In the window with glass, the effects are available in RAL colours 1015, 6005, 8014, 9010 and bright wood effect.

The window with ABS frame is available in RAL colours 1015, 6005, 7011, 7016, 8007, 8014 and 9010.

The window with aluminium frame is available in RAL colours 1015, 6005, 7011, 7016, 8014, 9010 and bright wood effect.

ACCESSORIES

LOCKS



Lock with Handle (exterior view)



Simple Lock (exterior view)



Outside Quick release (for residential engine)



Lock with Handle (interior view)



Simple lock (inside view)



ACCESSORIES

The components are of crucial importance in the operation of a door.

Each accessory is subjected to rigorous tests before being selected and included in the production process, to ensure the highest quality of the product that will fulfil our customer needs.

VENTILATION GRIDS



DIMENSIONS (LxA)
530x365 mm
Lacquered Aluminium Grid for better ventilation.



DIMENSIONS (LxA)
338x132 mm
Ventilation Grid in PVC for evacuation of toxic gases.

FLEXIDOOR PRESENTS THE ALUFRAME SYSTEM.

The new Aluminium Frame ensures durability and an exceptional exterior aesthetic finishing. It was designed to fix the spring system and the top rubber seal to the headroom. All associated with an exceptional level of robustness.

The system has multiple fitting options, either with or without any side wall or headroom. Minimum headroom of 130mm and side wall of 90mm. Multiple add-ons of 50mm.

SYSTEM ALUFRAME

PASS DOOR FLEXISTEP

FLEXISTEP
INNOVATION AT YOUR DOOR!

FINGER-SAFE SYSTEM

FlexiStep is absolute quality in every detail. Available in any RAL colour
The FlexiStep system has been tested and approved with an Initial Type Testing Report (CE-ITTR) by the Notified Body Cidemco.

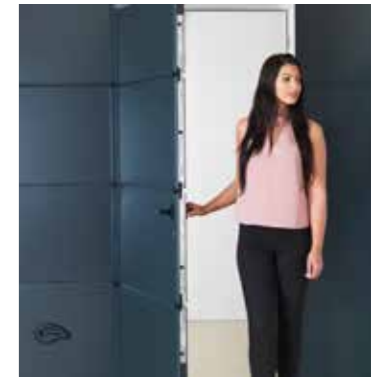

SPECIFICATIONS
Pedestrian door by
FlexiDoor



Rounded design with anodized or lacquered aluminium profiles



Low and safe lower threshold – easy passage



Strong construction



Intermediate hinges fixed on the aluminium profiles



Door closer



Pinch-proof caps - no danger for your fingers



4 Points lock – when higher protection is requested



Wireless pedestrian safety kit – for automatic doors (option)

INFO: Sectional door maximum width - 5000mm





LUXDOOR

Flexidoor presents its new Sectional LUX Door. An innovative design that will promote the aesthetics of any home or building. This door is composed of an aluminium structure identical to the structure of our BIG ALU door, however, is composed of phenolic panels, capable of withstand the most demanding weather conditions and may be exposed to sun, rain and cold, keeping its aesthetics unchanged.

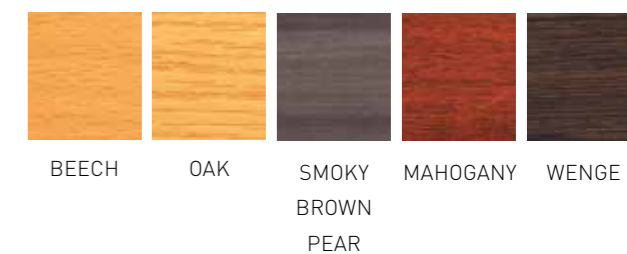

FEATURES:

- Structure of BIG ALU door in aluminium anodized or lacquered.
- Phenolic panels in Wenge, Mahogany, Beech, Oak and Smoky Brown Pear.
- For door width above 2900mm, it needs aluminium middle profiles.
- Can also be manufactured with an interior phenolic panel.

CUSTOMIZE YOUR **DOOR**

The Flexidoor sectional doors allow a coverage application according to each customer desire, like existing coverings used elsewhere in the building where the door will be installed.

AFTER ALL, IT'S YOUR DOOR!
OWN A UNIQUE DOOR!

NOTE: Coverings effects are applied by the customer.



CUSTOMIZE YOUR **DOOR**



CUSTOMIZE YOUR **DOOR**



CUSTOMIZATION

You can customize your door with the **image you desire.**

NOTE: Maximum door width: 3000 mm



NOW YOUR DOOR CAN BE CUSTOMIZED WITH **THE DESIGN YOU WANT**, THROUGH EFFECTS ON THE **PANEL SURFACE** MADE OF STAINLESS STEEL OR BRUSHED ALUMINIUM.

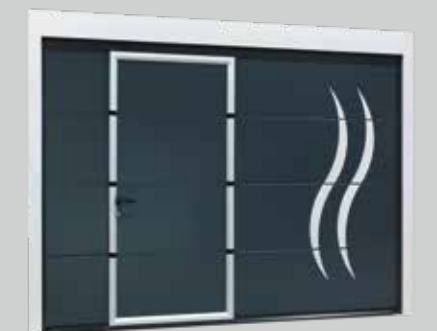

HEADROOMS

REAR SPRINGS

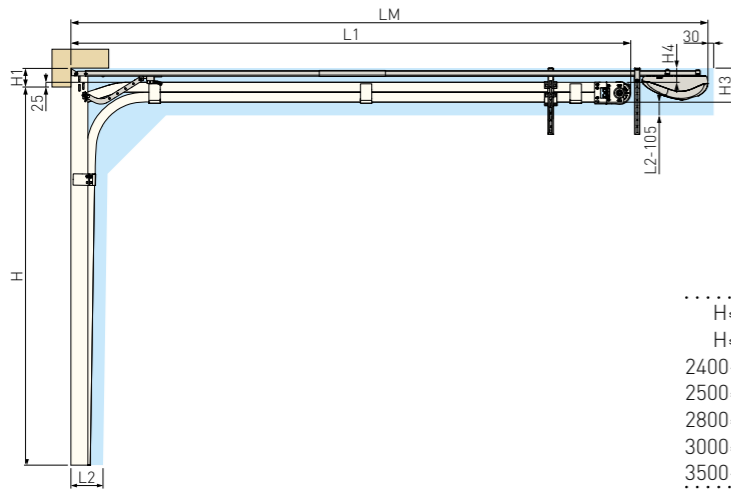

	L1	LM	H	H _{MIN}	H _{MAX}
H ≤ 2000	2555	3370	H	H1	Maximum height: 3680
H ≤ 2400	2955	3370	H	H1	Min. headroom: 100
2400 < H < 2500	H+555	3370	H	H3	H1 100 ≤ H1 < 130
2500 < H < 2800	H+555	4370	H	H4	H1 + 85
2800 < H < 3000	H+755	4370	H	H4	H1 - 25
3000 < H < 3500	H+800	4370	H		
3500 < H < 3680	H+800	-	H		

Dimensions em mm

NORMAL LIFT WITH INCLINATION

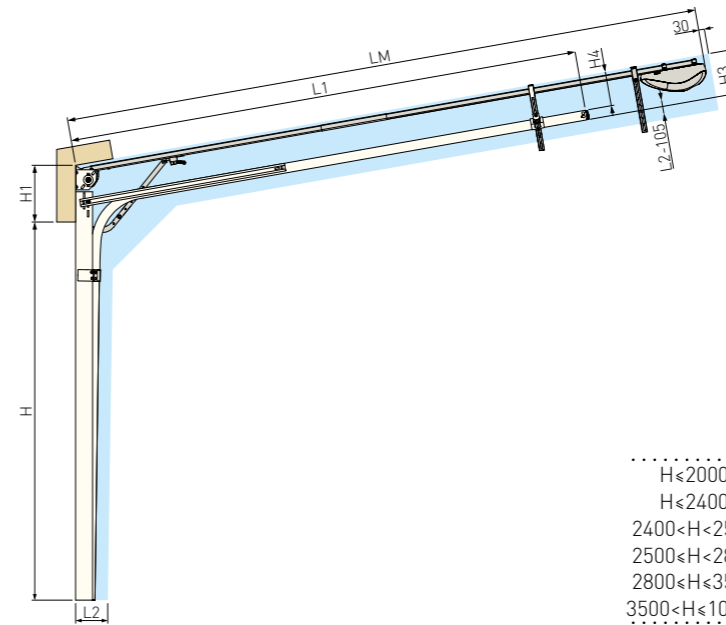

	L1	LM	H	H _{MIN}	H _{MAX}
H ≤ 2000	2396	3370	H	H1	Maximum height: 3680
H ≤ 2400	2796	3370	H	H1	Min. headroom: 300
2400 < H < 2500	H+396	3370	H	H3	H1 300 ≤ H1 < 420 H1 > 420
2500 < H < 2800	H+396	4370	H	H3	H1-90 H1-215
2800 < H < 3500	H+596	4370	H	H4	H1-145 H1-270
3500 < H < 10175	H+596	-	H		

Dimensions em mm

REDUCED LIFT

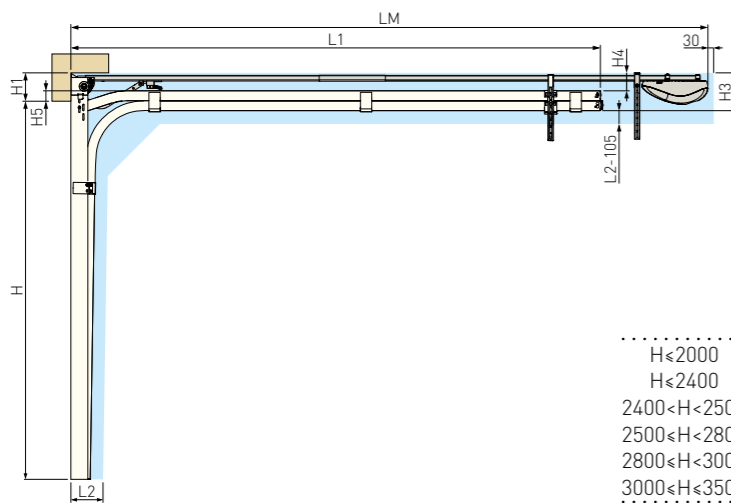

	L1	LM	H	H _{MIN}	H _{MAX}
H ≤ 2000	2394	3370	H	H1	Maximum height: 3200
H ≤ 2400	2794	3370	H	H1	Min. headroom: 130
2400 < H < 2500	H+394	3370	H	H3	H1 130 ≤ H1 < 150 150 ≤ H1 < 200
2500 < H < 2800	H+394	4370	H	H3	H1+55 H1+65
2800 < H < 3000	H+594	4370	H	H4	H1-55 H1-65
3000 < H < 3500	H+634	4370	H	H5	55 65

Dimensions em mm

NORMAL LIFT

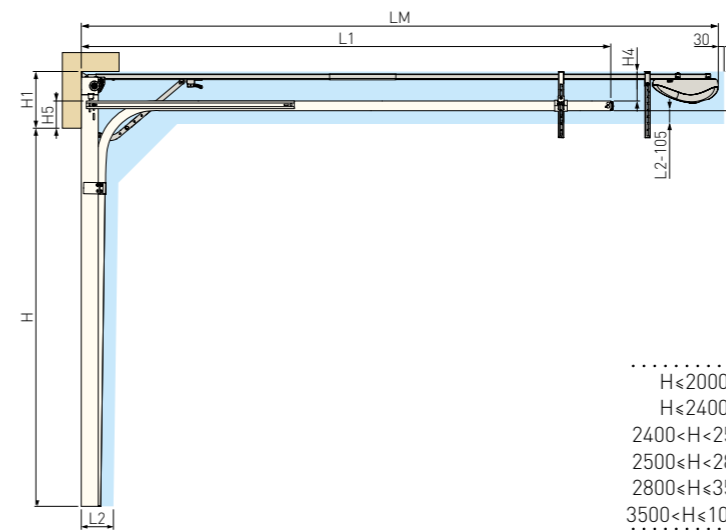

	L1	LM	H	H _{MIN}	H _{MAX}
H ≤ 2000	2396	3370	H	H1	Maximum height: 3680
H ≤ 2400	2796	3370	H	H1	Min. headroom: 300
2400 < H < 2500	H+396	3370	H	H3	H1 300 ≤ H1 < 420 H1 > 420
2500 < H < 2800	H+396	4370	H	H3	H1-90 H1-215
2800 < H < 3500	H+596	4370	H	H4	H1-145 H1-270
3500 < H < 10175	H+596	-	H	H5	145 270

Dimensions em mm

LOW LIFT

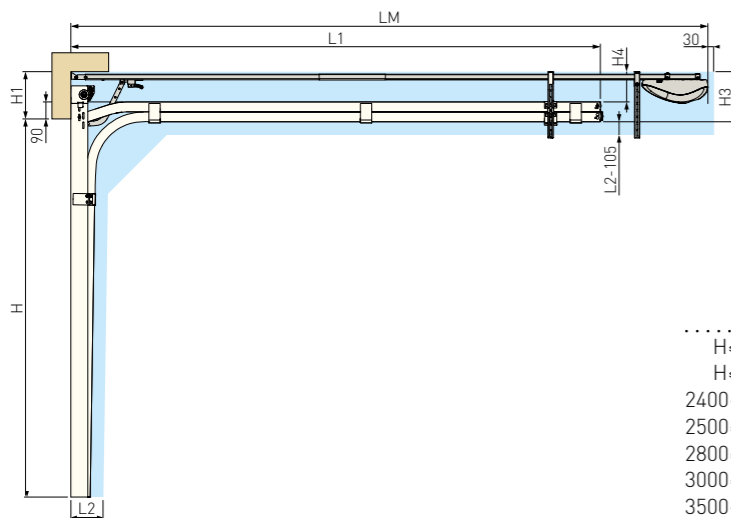

	L1	LM	H	H _{MIN}	H _{MAX}
H ≤ 2000	2396	3370	H	H1	Maximum height: 3680
H ≤ 2400	2796	3370	H	H1	Min. headroom: 200
2400 < H < 2500	H+396	3370	H	H3	H1 200 ≤ H1 < 300
2500 < H < 2800	H+396	4370	H	H3	H1 + 20
2800 < H < 3000	H+596	4370	H	H4	H1 - 90
3000 < H < 3500	H+636	4370	H		
3500 < H < 5570	H+636	-	H		

Dimensions em mm

HORIZONTAL VIEW

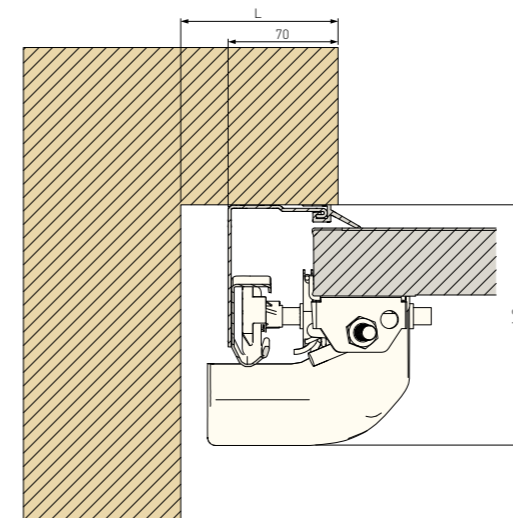

	A < 7m²	A < 16m²	A ≥ 16m²
L	100	120	100
L2	135	160	200

MOTOR FOR RESIDENTIAL DOORS

MOTOR FOR SECTIONAL AND UP-AND-OVER DOORS

LIKE IT is the latest innovation in home automation, with a range of solutions where high technology reigns. With different options in terms of power, the PRO delivers the performance of a motor

specially developed for the residential market, with easy programming functions, quality of conception and the elegance of a top design.

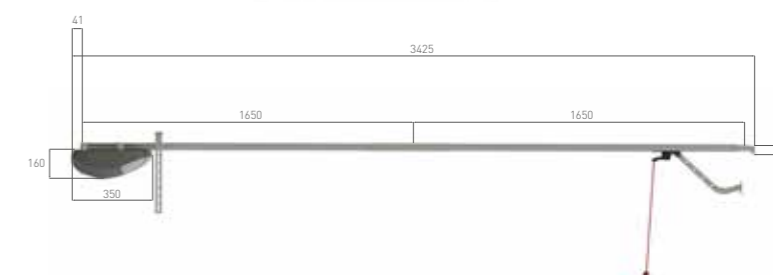

For doors with max. height of 2500mm

	PRO60	PRO80	PRO120
Power supply	230V 50Hz - 60Hz	230V 50Hz - 60Hz	230V 50Hz - 60Hz
Maximum door surface	8 m ²	12 m ²	16 m ²
Motor supply	24 Vdc	24 Vdc	24 Vdc
Power	100W	120W	150W
Decoding	Rolling Code	Rolling Code	Rolling Code
Working frequency	433,92 Mhz	433,92 Mhz	433,92 Mhz
Pulling force	600N	800N	1200N
Operating temperature	>-20°C, <+50°C	>-20°C, <+50°C	>-20°C, <+50°C
Protection level	30 IP	30 IP	30 IP
Speed	0,15 m/s	0,15 m/s	0,15 m/s
Duty cycle	45%	45%	45%
Relative humidity	≤ 90%	≤ 90%	≤ 90%
Courtesy light	LED	LED	LED
Motor dimensions	200x110x350 mm	200x110x350mm	200x110x350mm
Weight	3,5 kg	4,25kg	4,35kg
Command feed	Bat. CR 2016 3V (x2)	Bat. CR 2016 3V (x2)	Bat. CR 2016 3V (x2)
Door maximum height	2,5m*	2,5m*	2,5m*

*with the LKPRC12 part the maximum height is 3.5m

ACCESSORIES



DIGIWIRELESS

The selectors LIKE IT offers the DIGIWIRELESS, a digital wireless key selector with Rolling code 433.92 MHz technology that is easily fixed on a wall for a regular utilization.



FAST4

The new line of remote controls FAST4 are the perfect combination of factors like aesthetics, functionality and design, which added the elegance and versatility needed every day. The protective plastic, very resistant, ensures a perfect and lasting life.

FAST4	
Number of Channels	4
Encoding type	rolling-code
Transmission frequency	433,92MHz
Irradiated power	1mw
Encoding	64 bit
Maximum temperature	55°C
Capacity of signal	150-200m



VIS

The VIS photocell is an optical sensor with transmitter and receiver that work by infrared signal to detect the presence of obstacles, which function is to stop and reverse the door movement before it collide with a person or object in the area of operation.



FLASHING LIGHT

The beacon light is another component that Flexidoor provides as an option to be applied on its doors. Installing this component enables the signalization of the movements of our doors, functioning whenever they are closing or opening. As an alarm, it is undoubtedly a very efficient safety system allowing the pedestrian to easily check whether the door is in operation, avoiding possible accidents.



EXT2

The external receiver EXT2 have 2-channel rolling-code 433.92 MHz with 999 codes memory with plug-in for multiple applications.



WIRELESSBAND

Wireless pedestrian safety kit for automatic doors.

WELL-BEING
IS ALWAYS
ON OUR MIND!





RUA DA MAJOEIRA, Nº 400
APARTADO 542
2415 - 184 REGUEIRA DE PONTES
LEIRIA • PORTUGAL

TEL. +351 244 850 470

FAX. +351 244 850 471

INFO@FLEXIDOOR.PT

WWW.FLEXIDOOR.PT

CATRES.EN.05.21

DISTRIBUTOR

Cofinanciado por:

